

SBT-70 LEDs

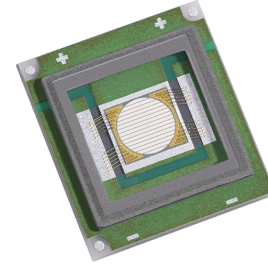

Table of Contents

Technology Overview2

Bin Structure.....3

Table of the Product , Product Shipping & Labeling Information.....4

Ordering Information5

G,B Optical & Electrical Characteristics.....6-8

Lifetime and Spectrum, Output vs Temp.....9

Thermal Resistance 10

Mechanical Dimensions 11-12

History of Changes 13

Features:

- Extremely high optical output from a 7 mm² circular emitter:
 - Over 2,000 green lumens at 10.5A
 - Over 200 blue lumens at 10.5A and 445nm
 - Refer to SBT-90-R for companion red product
- Round emitting aperture provides most efficient match to circular optical systems and narrow beam projectors
- Unencapsulated die with low profile protective window optimizes optical coupling in etendue-limited applications
- High thermal conductivity package - junction to case thermal resistance of only 0.64°C/W
- Variable drive current up to 10.5 A continuous wave. Up to 2A/mm² in pulsed conditions
- Environmentally friendly: RoHS compliant

Applications

- Architectural and Entertainment Lighting
- Fiber-coupled Illumination
- Medical Lighting
- Machine Vision
- Microscopy
- Spot Lighting

Technology Overview

Luminus LEDs™ benefit from a suite of innovations in the fields of LED die technology, packaging and thermal management. These breakthroughs allow illumination engineers and designers to achieve solutions that are high brightness and high efficiency.

Luminus Technology

Luminus' technology enables large area LED chips with uniform brightness over the entire LED chip surface. The optical power and brightness produced by these large monolithic chips enable solutions which replace arc and halogen lamps where arrays of traditional high power LEDs cannot.

Packaging Technology

Thermal management is critical in high power LED applications. With a thermal resistance from junction to case of 0.64°C/W , Luminus SBT-70 LEDs have the lowest thermal resistance of any LED on the market. This allows the LED to be driven at higher current densities while maintaining a low junction temperature, thereby resulting in brighter solutions and longer lifetimes.

Reliability

Designed from the ground up, Luminus LEDs are one of the most reliable light sources in the world today. Luminus LEDs have passed a rigorous suite of environmental and mechanical stress tests, including mechanical shock, vibration, temperature cycling and humidity, and have been fully qualified for use in extreme high power and high current applications. With very low failure rates and median lifetimes that typically exceed 60,000 hours, Luminus LEDs are ready for even the most demanding applications.

Environmental Benefits

Luminus LEDs help reduce power consumption and the amount of hazardous waste entering the environment. All LED products manufactured by Luminus are RoHS compliant and free of hazardous materials, including lead and mercury.

Understanding Big Chip LED Test Specifications

Every Luminus LED is fully tested to ensure that it meets the high quality standards expected from Luminus' products.

Testing Temperature

Luminus surface mount LEDs are typically tested with a 20 ms input pulse and a junction temperature of 25°C . Expected flux values in real world operation can be extrapolated based on the information contained within this product data sheet.

SBT-70 G, B Binning Structure (T_j= 25°C)

SBT-70 monochromatic LEDs are tested for luminous flux and dominant wavelength at a 10.5 A (1.5 A/mm²) drive current and placed into one of the following flux and wavelength bins. The binning structure is universally applied across each monochromatic color.

Flux Bins (measured at 10.5A drive current)

Color	Luminous Flux Bin (FF)	Minimum Flux	Maximum Flux
Green	CK	1500	2000
	CM	2000	2300
	CN	2300	2600
Blue	DF	120	160
	DG	160	200
	DH	200	250

*Note: Luminus maintains a +/- 6% tolerance on flux measurements.

Wavelength Bins Measured at 10.5 A drive current

Color	Wavelength Bin (WW)	Minimum Wavelength	Maximum Wavelength
Green	G4	520	525
	G5	525	530
	G6	530	535
	G7	535	540
Blue	B1	435	440
	B2	440	445
	B3	445	450
	B4	450	455

Product Shipping & Labeling Information

All SBT-70 products are packaged and labeled with their respective bin as outlined in the tables on page 3. When shipped, each package will only contain one bin. The part number designation is as follows:

SBT-70-G, B

SBT — 70 — N — F75 — FF — WW

Product Family	Chip Area	Color	Package Configuration	Flux Bin	Wavelength Bin
Surface Mount (window)	7.0 mm ²	G: Green B: Blue	Internal Code	See page 3 for flux bins	See page 3 for wavelength bins

Example:

The part number SBT-70-B-F75-DH-B2 refers to a BLUE, SBT-70 surface mount, with a flux range of 200 - 250 lumens and a wavelength range of 440 nm to 445 nm.

Note: Some flux and wavelength bins may have limited availability. Application specific bin kits, consisting of multiple bins, may be available.

Table of Products

Products	Ordering Part Number	Description
SBT-70-G	SBT-70-G-F75-xx123	SBT-70 surface mount device consisting of a 7.0 mm ² LED on ceramic substrate
SBT-70-B	SBT-70-B-F75-xx123	
SBR-70-G	SBR-70-G-R75-xx123	SBR-70 evaluation module consisting of a SBT-70 surface mount device mounted on an aluminum star board
SBR-70-B	SBR-70-B-R75-xx123	

Please refer to page 5 for orderable bin kits.

SBT-70 and SBR-70 Bin Kit Order Codes

Color	Luminous Flux		Wavelength Bins	Kit Number
	Bin Kit Flux Code	Min. Flux		
Green	JK	1500	G4, G5, G6, G7	JK200
			G4, G5	JK201
			G6, G7	JK202
	JM	2000	G4, G5, G6, G7	JM200
			G4, G5	JM201
			G6, G7	JM202
Blue	KF	120	B1,B2,B3,B4	KF300
			B2,B3	KF301
	KG	160	B1,B2,B3,B4	KG300
			B2,B3	KG301

SBT-70 G, B, Optical & Electrical Characteristics

Green			
Drive Condition ¹		10.5 A	
Parameter	Symbol	Values ³	Unit
Current Density	j	1.5	A/mm ²
Forward Voltage	V _{F min}	3.9	V
	V _F	4.5	V
	V _{F max}	5.3	V
Luminous Flux ⁴	Φ _{V typ}	2100	lm
Dominant Wavelength ⁵	λ _d	530	nm
FWHM	Δλ _{1/2}	32	nm
Chromaticity Coordinates ^{5,6}	x	0.182	-
	y	0.732	-

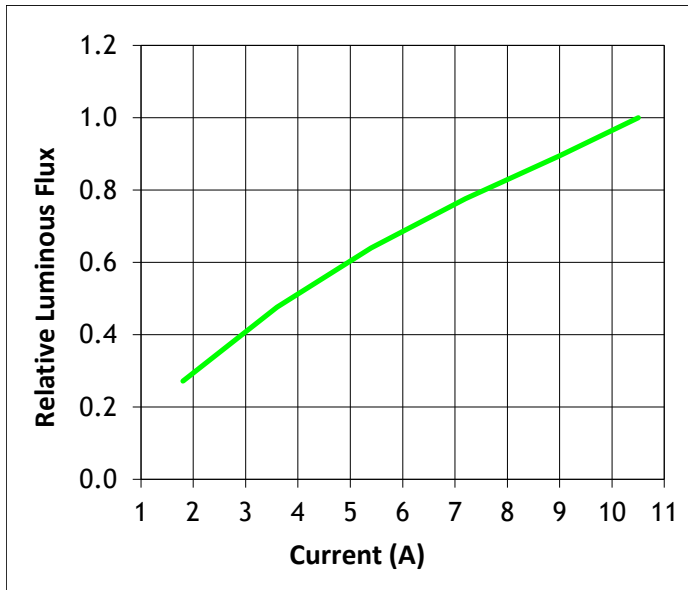
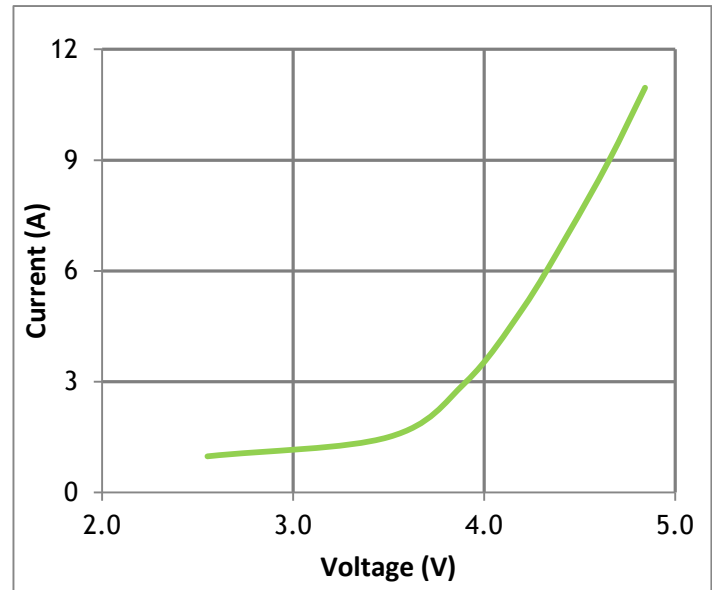
Relative Luminous Flux vs. Forward Current²

Forward Current vs. Forward Voltage

For notes see page 8.

SBT-70 G, B, Optical & Electrical Characteristics

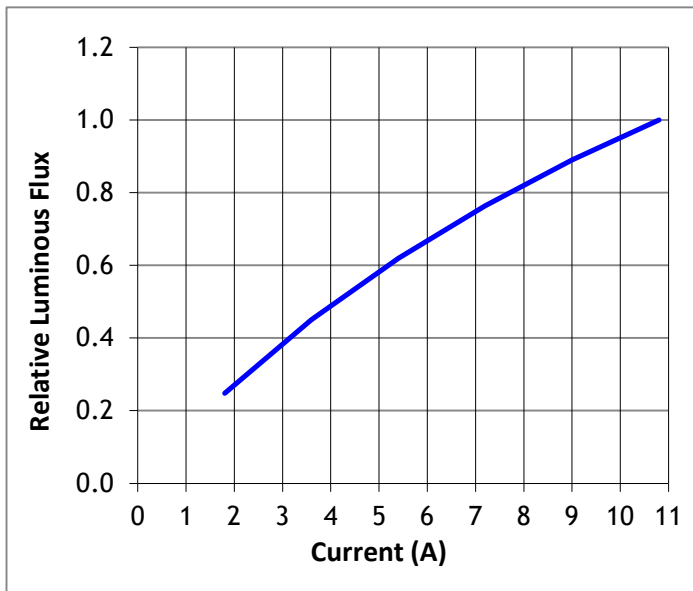
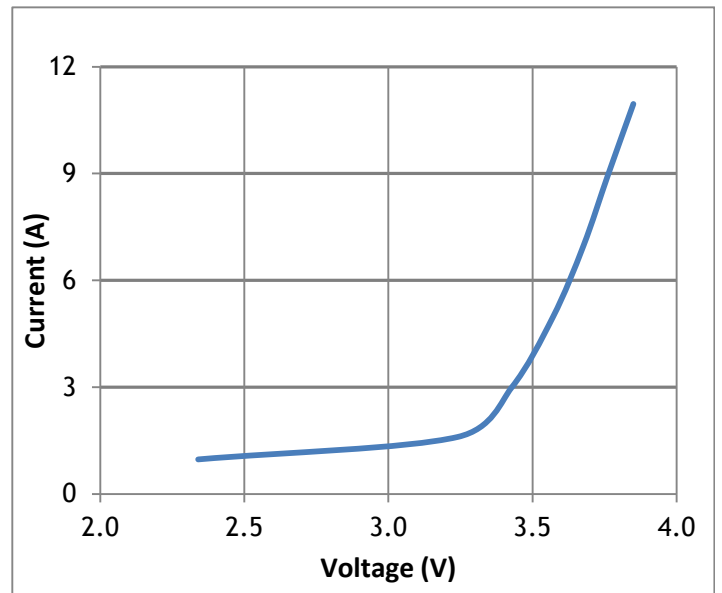
Blue			
Drive Condition ¹		10.5 A	
Parameter	Symbol	Values ³	Unit
Current Density	j	1.5	A/mm ²
Forward Voltage	$V_{F\min}$	3.2	V
	V_F	3.8	V
	$V_{F\max}$	4.2	V
Luminous Flux ⁴	$\Phi_{V\text{typ}}$	200	lm
Dominant Wavelength ⁵	λ_d	445	nm
Radiometric Flux	$\Phi_{p\text{typ}}$	9.5	W
FWHM	$\Delta\lambda_{1/2}$	19	nm
Chromaticity Coordinates ^{5,6}	x	0.158	-
	y	0.018	-

Relative Luminous Flux vs. Forward Current²

Forward Current vs. Forward Voltage

For notes see page 8.

SBT-70, G, B, Optical & Electrical Characteristics Notes

- Note 1: Listed drive conditions are typical for common applications. SBT-70 G,B devices can be driven at currents ranging from 1 A to 10.5 A and at duty cycles ranging from 1% to 100%. Drive current and duty cycle should be adjusted as necessary to maintain the junction temperature desired to meet application lifetime requirements.
- Note 2: All ratings are based on a junction test temperature $T_j = 25^\circ\text{C}$. See Thermal Resistance section for T_j definition.
- Note 3: Unless otherwise noted, values listed are typical. Devices are production tested and specified at 10.5A. Other values are for reference only.
- Note 4: Total flux from emitting area at listed dominant wavelength. Reported performance is included to show trends for a selected power level. For specific minimum and maximum values, use bin tables. For product roadmap and future performance of devices, contact Luminus.
- Note 5: In CIE 1931 chromaticity diagram coordinates, normalized to $X+Y+Z=1$.
- Note 6: For reference only.

SBT-70-G, B

Common Characteristics

	Symbol	Green	Blue	Unit
Emitting Area		7.0	7.0	mm ²
Emitting Area (Diameter)		3	3	mm
Thermal Coefficient of Photometric Flux		-0.2	-0.2	%/ °C
Thermal Coefficient of Radiometric Flux		-0.2	-0.2	%/ °C
Thermal Coefficient of Junction Voltage		-4.6	-3.5	mV/ °C

Absolute Maximum Ratings

	Symbol	Green	Blue	Unit
Minimum Current		0.2	0.2	A
Maximum Current ⁷		14	14	A
Maximum Junction Temperature ⁸	T_{jmax}	150	150	°C
Storage Temperature Range		-40/+100	-40/+100	°C

- Note 7: Luminus LEDs are designed for operation to an absolute maximum current as specified above. Product lifetime data is specified at recommended forward drive currents. Sustained operation at or beyond absolute maximum currents will result in a reduction of device lifetime compared to recommended forward drive currents. Actual device lifetimes will also depend on junction temperature. Refer to the lifetime derating curves for further information. In pulsed operation, rise time from 10-90% of forward current should be larger than 0.5 microseconds.
- Note 8: Lifetime dependent on LED junction temperature. Input power and thermal system must be properly managed to ensure lifetime. See charts on pg 9 for further information.

SBT-70- G, B Output vs. Temp., Lifetime and Spectrum

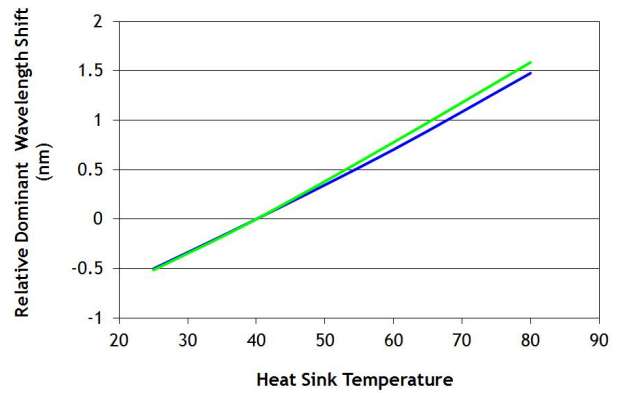
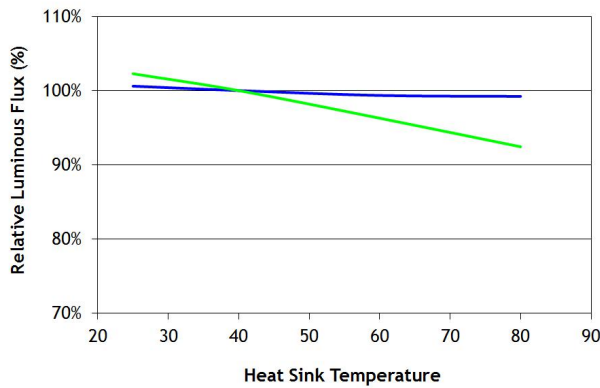

Median Lifetime Estimate vs. Tj¹

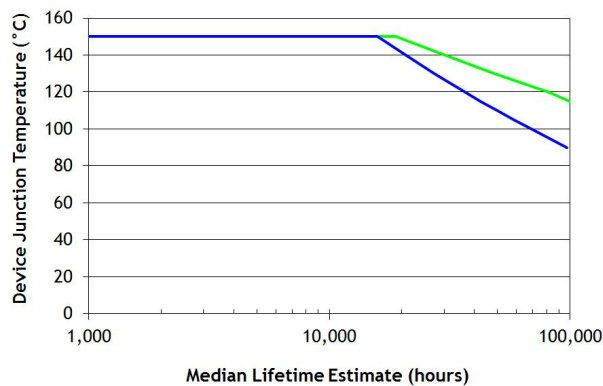

Lumen Maintenance²

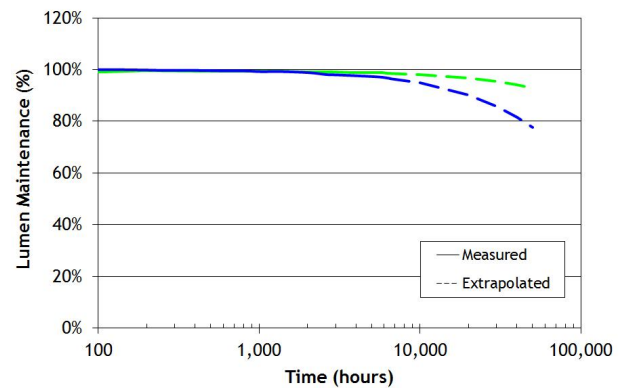

Typical Spectrum³

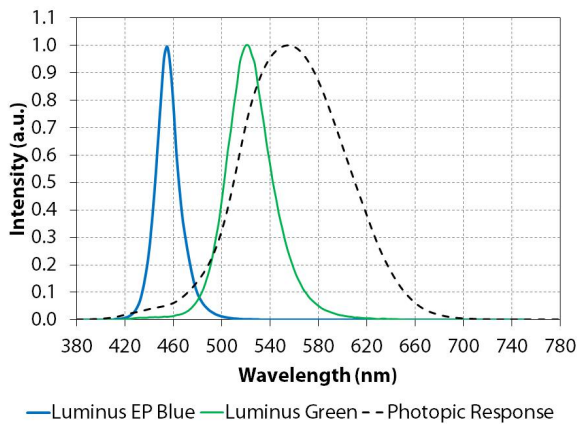

Angular Distribution

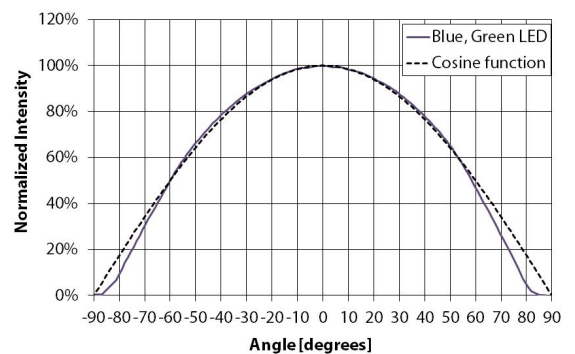

Note 1. Median lifetime estimate as a function of junction temperature at 1.5A/mm² in continuous operation. Lifetime defined as time to 70% of initial intensity. Based on preliminary lifetime test data. Data can be used to model failure rate over typical product lifetime.

Note 2. Lumen maintenance vs. time at 1.5A/mm² in continuous operation, junction temperature equal to 25°C.

Note 3. Typical spectrum at current density of 1.5 A/mm² in continuous operation.

Thermal Resistance

Thermal Resistance Model

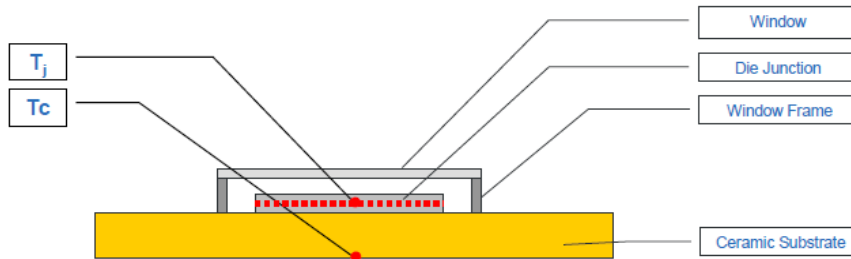

Typical Thermal Resistance :

R_{j-c}^1	0.64 °C/W
R_{j-b}^1	2.02 °C/W
R_{j-hs}^2	2.15 °C/W

Note 1: Thermal resistance values are based on FEA model results correlated to measured $R_{\theta j-hs}$ data.

Note 2: Thermal resistance is measured using a SAC305 solder, a Bergquist Al-clad MCPCB, and eGraf 1205 thermal interface material.

Note: Thermal resistance values are preliminary based on modeled results.

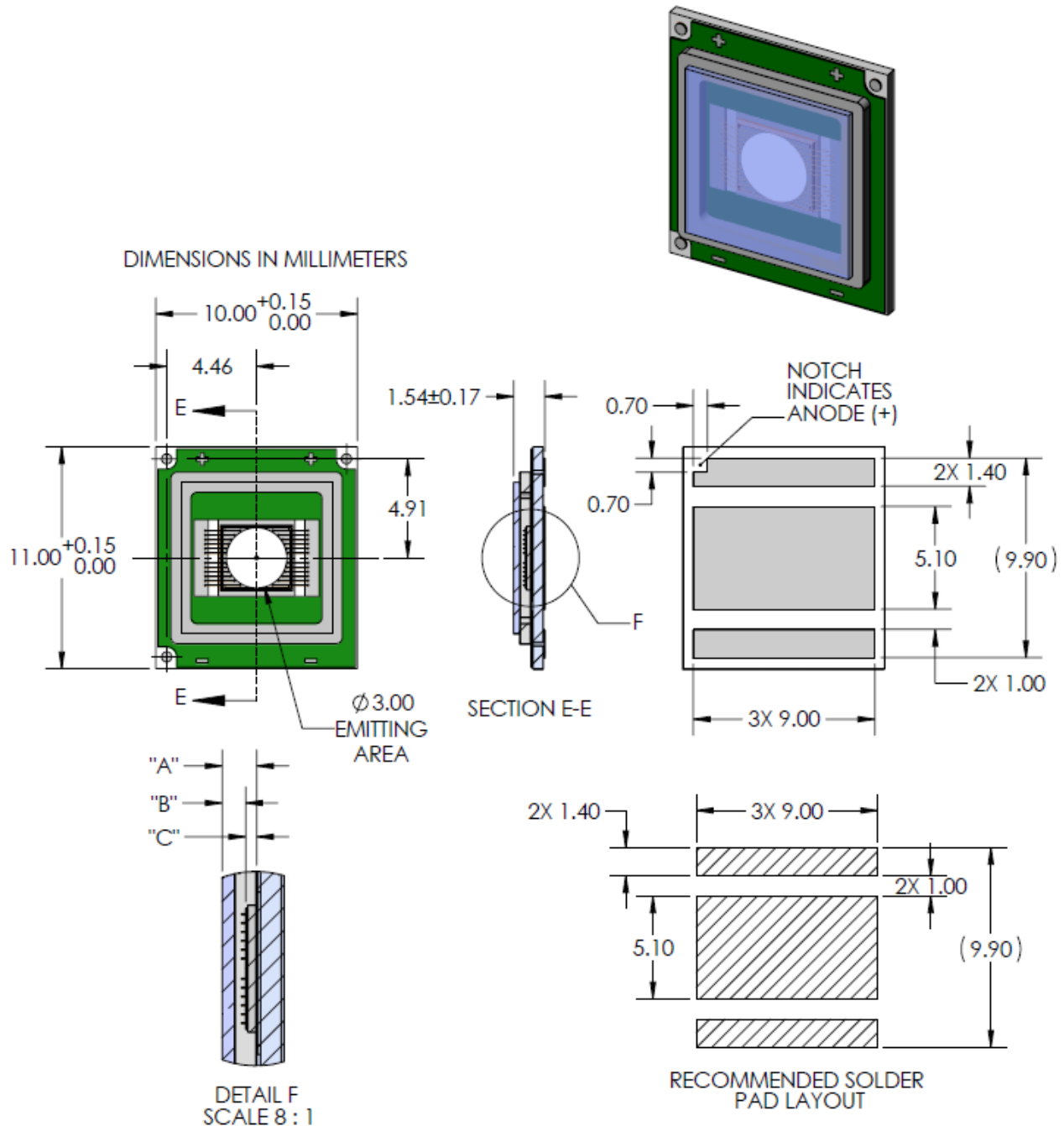
Mechanical Dimensions – SBT-70 Emitter

DIMENSION NAME	DESCRIPTION	NOMINAL DIMENSION	TOLERANCE
"A"	TOP OF CERAMIC SUBSTRATE TO TOP OF GLASS	.86	± 0.10
"B"	TOP OF EMITTING AREA TO TOP OF GLASS	.58	± 0.14
"C"	TOP OF CERAMIC SUBSTRATE TO TOP OF EMITTING AREA	.28	± 0.03

DWG-002087

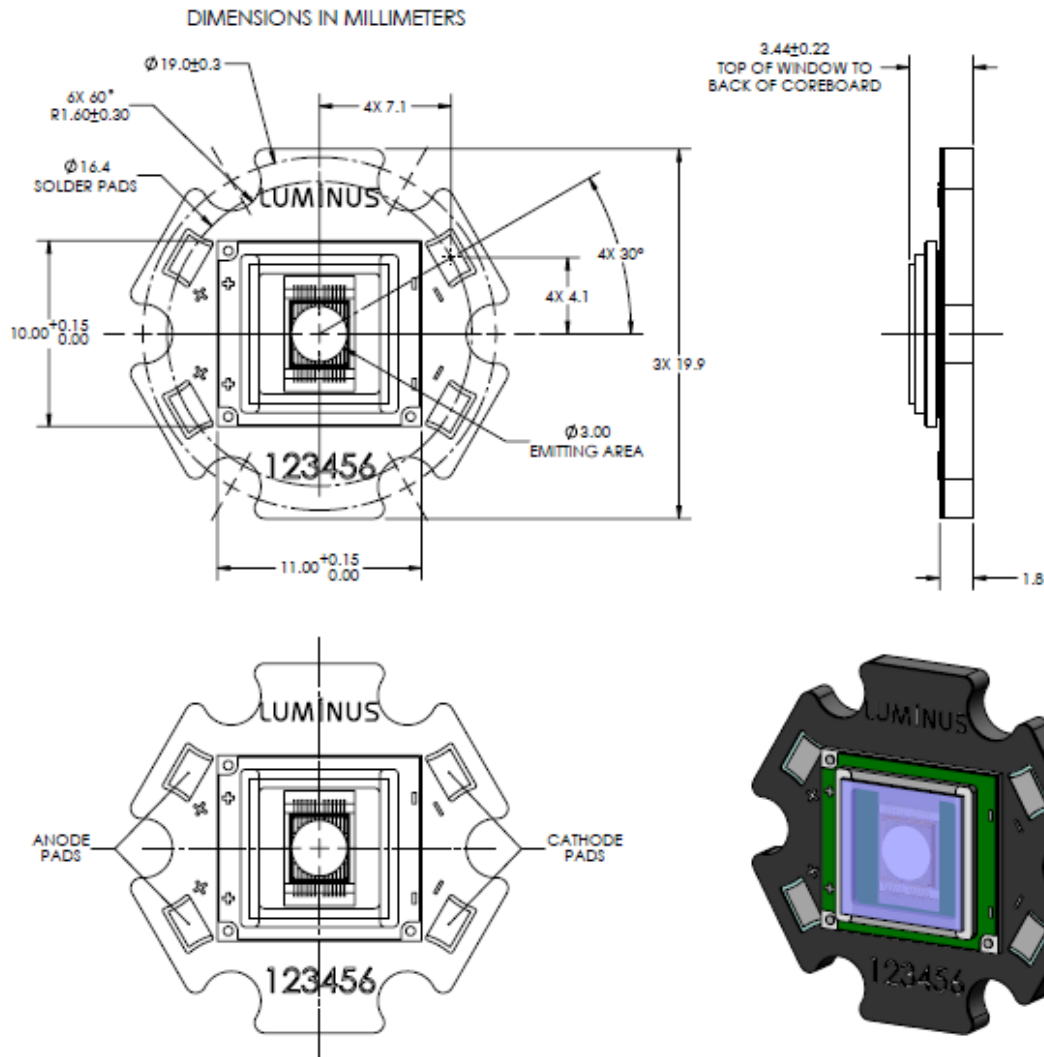
Mechanical Dimensions – SBT-70 Star Board

DWG-002153

- Note 1: Tolerances per IPC-610, Class 2. All dimensions in millimeters
- Note 2: For detail drawing of SBT-70, please see DWG-002087
- Note 3: Recommended mounting screw: M3 or #4
- Note 4: All anode pads and all cathode pads on board are interconnected.

History of Changes

Rev	Date	Description of Change
08	07/20/2015	Added Angular Distribution Pattern on Page 9
09	04/10/2016	Updated Vf min for SBT-70-G from 4.5V to 3.9V and typical Vf from 4.9V to 4.5V Corrected maximum current value to 14A (2A/mm ²) on page 8

The products, their specifications and other information appearing in this document are subject to change by Luminus Devices without notice. Luminus Devices assumes no liability for errors that may appear in this document, and no liability otherwise arising from the application or use of the product or information contained herein. None of the information provided herein should be considered to be a representation of the fitness or suitability of the product for any particular application or as any other form of warranty. Luminus Devices' product warranties are limited to only such warranties as accompany a purchase contract or purchase order for such products. Nothing herein is to be construed as constituting an additional warranty. No information contained in this publication may be considered as a waiver by Luminus Devices of any intellectual property rights that Luminus Devices may have in such information. LEDs™ is a registered trademark of Luminus Devices, Inc., all rights reserved.

This product is protected by U.S. Patents 6,831,302; 7,074,631; 7,083,993; 7,084,434; 7,098,589; 7,105,861; 7,138,666; 7,166,870; 7,166,871; 7,170,100; 7,196,354; 7,211,831; 7,262,550; 7,274,043; 7,301,271; 7,341,880; 7,344,903; 7,345,416; 7,348,603; 7,388,233; 7,391,059 Patents Pending in the U.S. and other countries.